

Shape, space & measures: Sheet 1 of 6

Page 27 Time & timetables

5 a

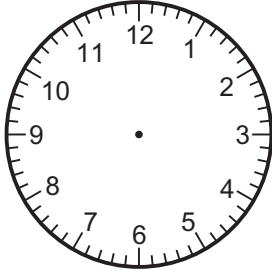

b

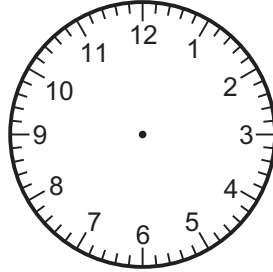

c

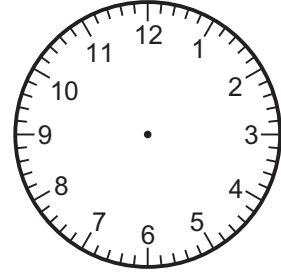

d

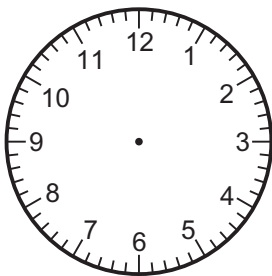

e

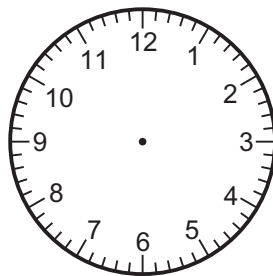

f

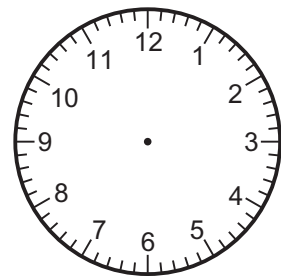

Page 28 Compass bearings & angles

1

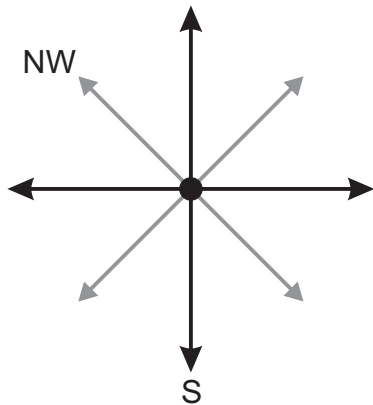

Shape, space & measures: Sheet 2 of 6

Page 30 Symmetry

1 a

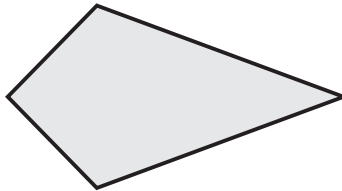

b

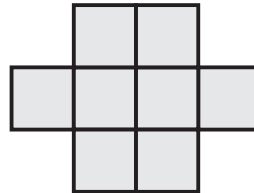

c

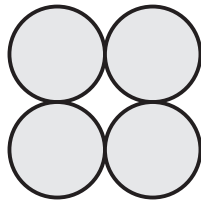

d

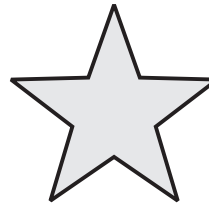

Page 31 Triangles & other polygons

2

Name of polygon	Number of sides	All sides equal?	All angles equal?	Number of lines of symmetry	Order of rotation symmetry
Square					
Rectangle					
Isosceles triangle					
Equilateral triangle					
Rhombus					
Kite					
Trapezium					
Regular pentagon					
	4	No	No	0	2

Shape, space & measures: Sheet 3 of 6

Page 32 Reflection

1 a

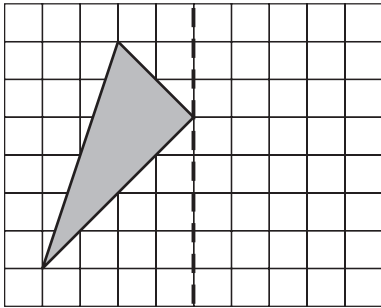

b

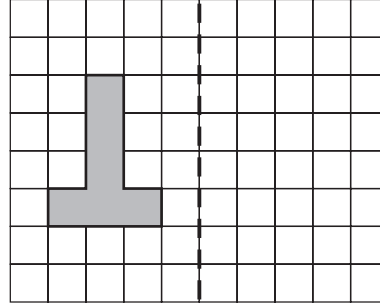

c

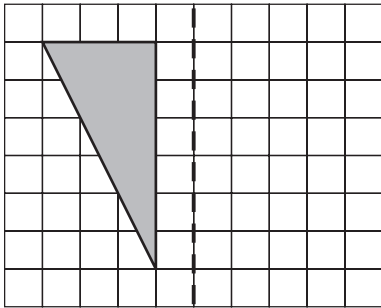

d

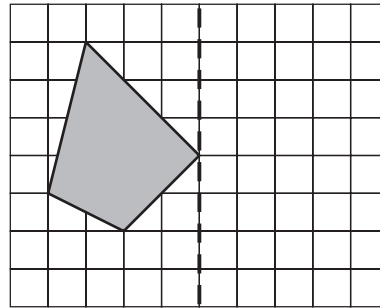

2 a

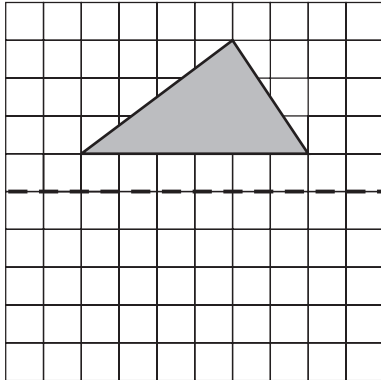

b

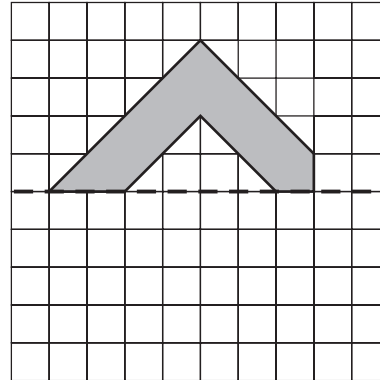

c

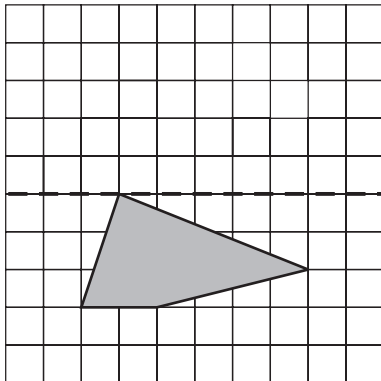

d

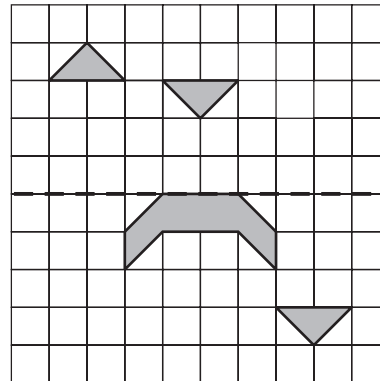

Shape, space & measures: Sheet 4 of 6

Page 32 Reflection

3

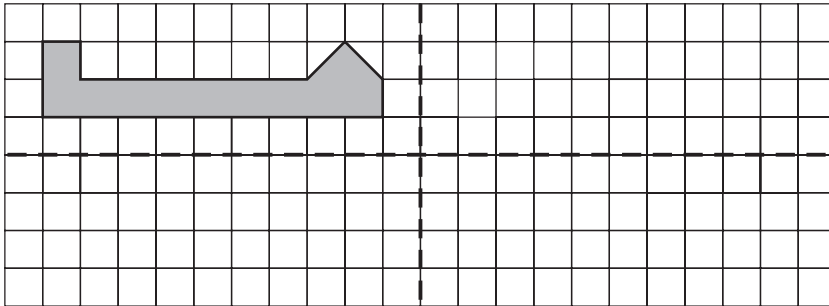

Page 33 Rotation

1 a

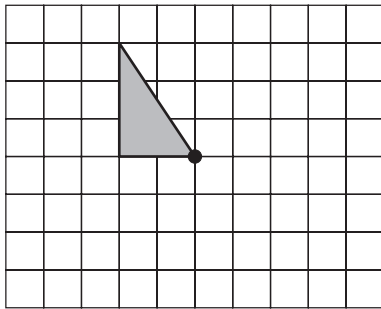

b

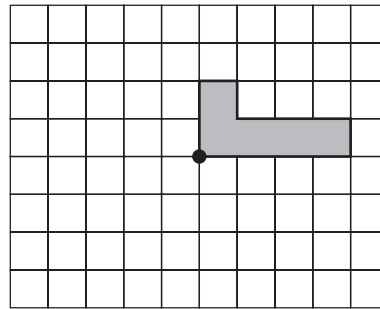

c

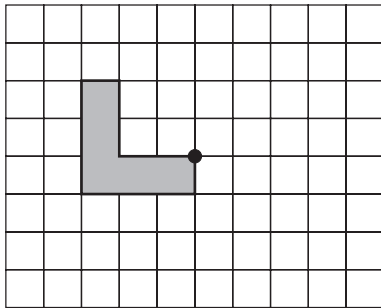

d

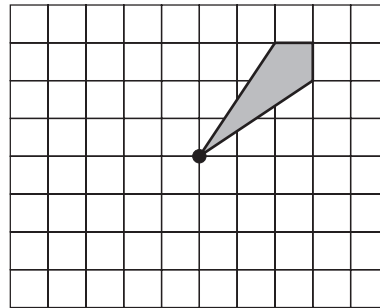

Shape, space & measures: Sheet 5 of 6

Page 33 Rotation

2 a

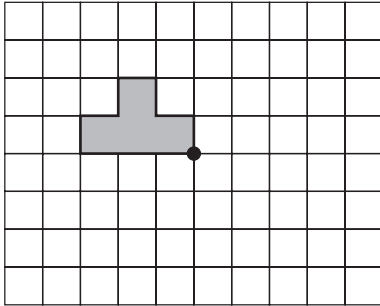

b

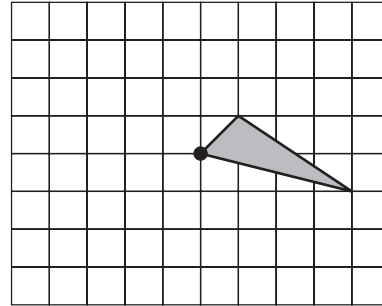

c

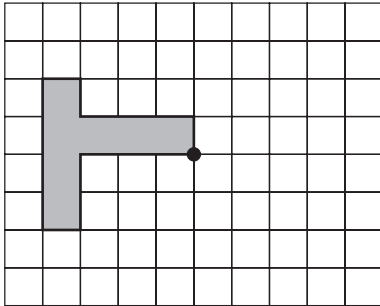

d

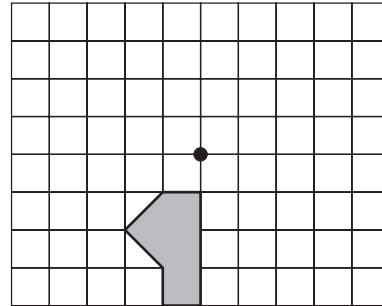

3 a

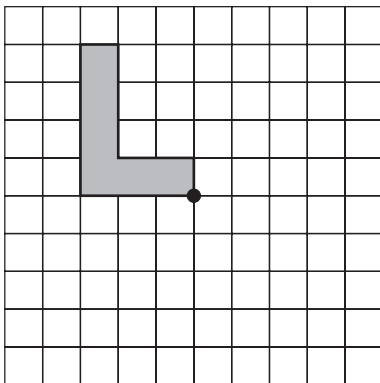

b

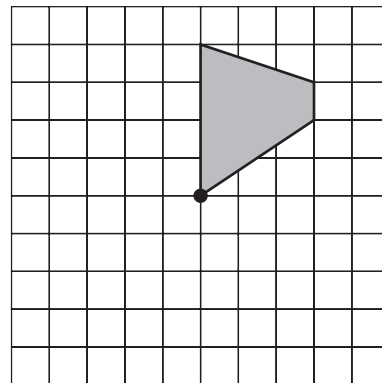

Shape, space & measures: Sheet 6 of 6

Page 34 Translation

1 a

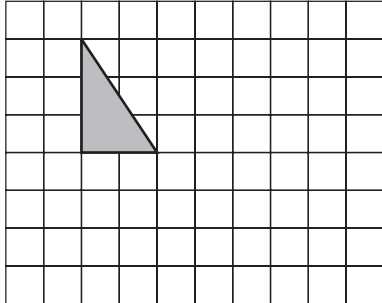

b

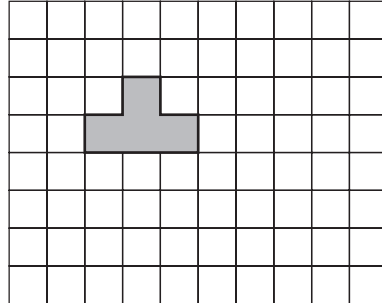

2 a

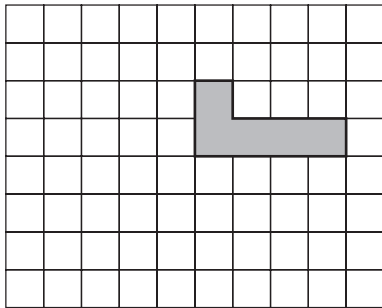

b

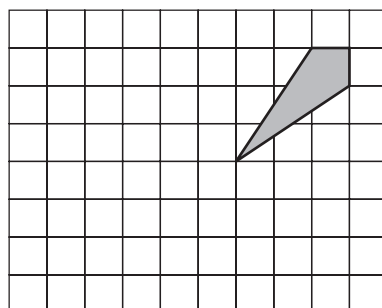

3 a

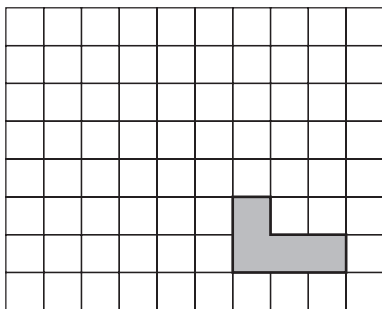

b

